

Data sheet

# Pressure independent control valve with integrated flow limiter AVQM (PN 16) - return and flow mounting

Description



AVQM is a self-acting flow controller with integrated control valve developed for the use in district heating / cooling systems. The controller prevents flow to exceed set max flow. In a combination with electrical actuators AMV(E) and ECL electronic controllers the flow and temperature can be controlled to achieve highest energy savings.

AVQM has a control valve with adjustable flow limiter, connection neck for electrical actuator and a pressure actuator with one control diaphragm.

Controllers are used together with Danfoss electrical actuators:

- AMV 150 <sup>1)</sup>
- AMV(E) 10 <sup>1)</sup> / AMV(E) 20 / AMV(E) 30
- AMV(E) 13 <sup>1)</sup> / AMV(E) 23 / AMV(E) 33 with spring return function
- AMV 20 SL / AMV 23 SL / AMV 30 SL with stroke limitation

<sup>1)</sup> AMV 150 / AMV(E) 10 / AMV(E) 13 can be combined with DN 15 controller only.

AVQM combined with AMV(E) 13, AMV(E) 23 (SL) or AMV(E) 33 (SL) has been approved according to DIN 32730.

**Main data:**

- DN 15-32
- $k_{VS}$  0.4-10 m<sup>3</sup>/h
- Flow range 0.015-6.0 m<sup>3</sup>/h
- PN 16
- Differential pressure over control valve  $\Delta p_{MCV}$  0.2 bar
- Temperature:  
Circulation water / glycolic water up to 30 %  
2 ... 150 °C
- Connections:  
Ext. thread (weld-on, thread and flange tailpieces)

Ordering

Example:  
Flow controller with integrated control valve for flow rate 0.7 m<sup>3</sup>/h; PN 16; T<sub>max</sub> 150 °C; ext. thread

- 1x AVQM DN 15 controller  
Code No: **003H6735**

Option:

- 1x Weld-on tailpieces  
Code No: **003H6908**

The controller will be delivered completely assembled, inclusive impulse tube between valve and actuator. Electrical actuator AMV(E) must be ordered separately.

AVQM Controller

Picture	DN (mm)	Q <sub>max</sub> (m <sup>3</sup> /h)	k <sub>VS</sub> (m <sup>3</sup> /h)	Connection	Code No.	
	15	0.18	0.4	Cylindr. ext. thread acc. to ISO 228/1	G 3/4 A	<b>003H6733</b>
		0.4	1.0			<b>003H6734</b>
		0.9	1.6			<b>003H6735</b>
		1.6	2.5			<b>003H6736</b>
		2.4	4.0			<b>003H6737</b>
		3.5	6.3			G 1 A
	20	4.5	8.0		G 1 1/4 A	<b>003H6739</b>
	25	6	10		G 1 3/4 A	<b>003H6740</b>
	32					

Ordering (continuous)

Accessories

Picture	Type designation	DN	Connection	Code No.
	Weld-on tailpieces	15	-	003H6908
		20		003H6909
		25		003H6910
		32		003H6911
	External thread tailpieces	15	Conical ext. thread acc. to EN 10226-1	R 1/2 003H6902
		20		R 3/4 003H6903
		25		R 1 003H6904
		32		R 1 1/4 003H6905
	Flange tailpieces	15	Flanges PN 25, acc. to EN 1092-2	003H6915
		20		003H6916
		25		003H6917

Service kits

Picture	Type designation	DN	$k_{vs}$ (m <sup>3</sup> /h)	Code No.
	Valve insert	15	0.4	003H6861
			1.0	003H6862
			1.6	003H6863
			2.5	003H6864
			4.0	003H6865
		20	6.3	003H6996
		25	8.0	003H6867
32	10			
	Control valve insert	15	0.4	003H6886
			1.0	003H6887
			1.6	003H6888
			2.5	003H6889
			4.0	003H6890
		20	6.3	003H6891
		25	8.0	003H6892
		32	10	003H6795
	Type designation	Δp setting range (bar)		Code No.
	Actuator	0.2		003H6825

Technical data

Valve

Nominal diameter		DN	15					20	25	32	
k <sub>VS</sub> value of dp controller			0.4	1.0	1.6	2.5	4.0	6.3	8.0	10	
Range of max. flow setting	Δp <sub>MCV</sub> = 0.2 bar	Q <sub>min</sub>	0.015	0.02	0.03	0.07	0.07	0.16	0.2	0.16	
		Q <sub>max</sub> <sup>2)</sup>	0.18	0.4	0.9	1.6	2.4	3.5	4.5	6.0	
Available Δp required for Q <sub>max</sub>		bar	0.4	0.4	0.5	0.6	0.6	0.5	0.5	0.6	
Stroke		mm	5					7			
Control valve authority		1 (100%) in the range of flow setting									
Control characteristic		Logarithmic									
Cavitation factor z		≥ 0.6							≥ 0.55		
Leakage acc. to standard IEC 534		% of k <sub>VS</sub>	≤ 0.02							≤ 0.05	
Nominal pressure		PN	25								
Min. differential pressure		bar	see remark <sup>1)</sup>								
Max. differential pressure			12								
Medium		Circulation water / glycolic water up to 30%									
Medium pH		Min. 7, max. 10									
Medium temperature		°C	2 ... 150								
Connections	valve	External thread									
	tailpieces	Weld-on and external thread							Flange		-
<b>Materials</b>											
Valve body		Red bronze CuSn5ZnPb (Rg5)									
Valve seat		Stainless steel, mat. No. 1.4571									
Valve cone		Dezincing free brass CuZn36Pb2As									
Sealing DP		EPDM									
Sealing MCV		Metal									
Pressure relieve system	Control valve insert	-									
	Valve insert	Piston									

Note:

DP - diff. pressure controller, MCV - control valve

<sup>2)</sup> For flows smaller than Q<sub>max</sub> → Δp<sub>min</sub> =  $\left(\frac{Q}{k_{VS}}\right)^2 + \Delta p_{MCV}$

Actuator

Type	AVQM	
Actuator size	cm <sup>2</sup>	39
Nominal pressure	PN	16
Differential pressure over MCV - motorized control valve	bar	0.2
<b>Materials</b>		
Housing	Zinc plated, DIN 1624, No. 1.0338	
Diaphragm	EPDM	
Impulse tube	Copper tube Ø 6 × 1 mm	

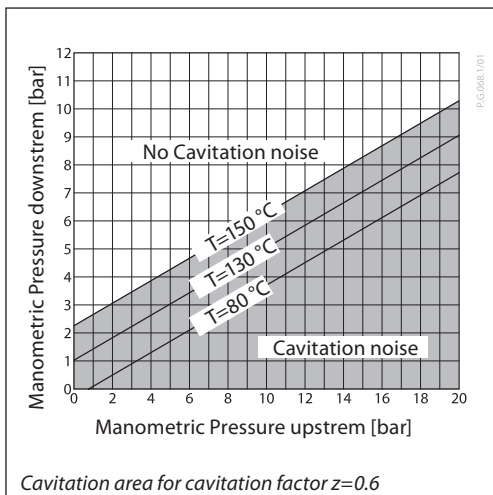

Application principles

Return mounting

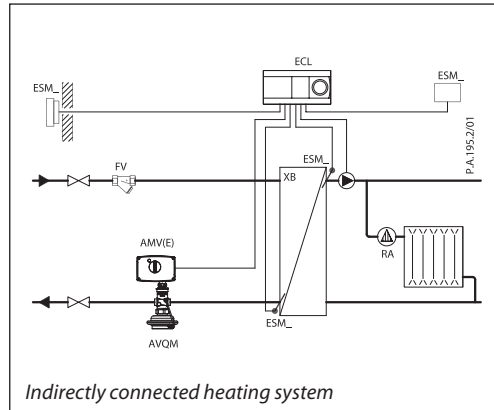

Flow mounting

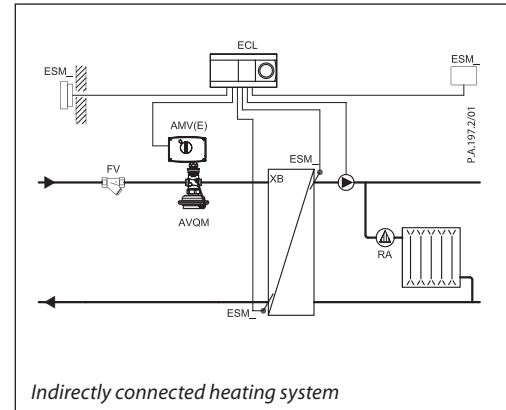

Installation positions

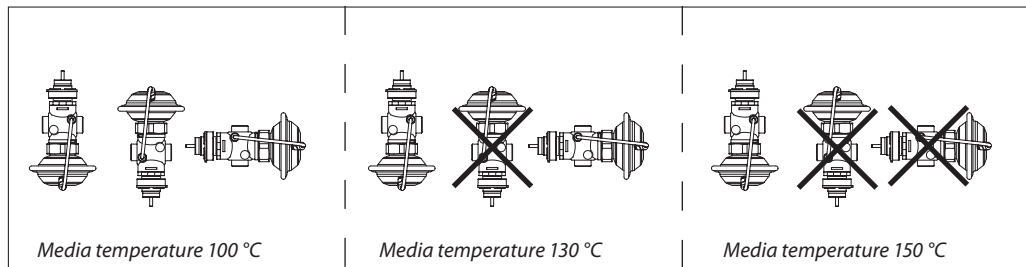

Electrical actuator

*Note!*  
Installation positions for electrical actuators AMV(E) have to be observed as well. Please see relevant Data sheet.

Pressure temperature diagram

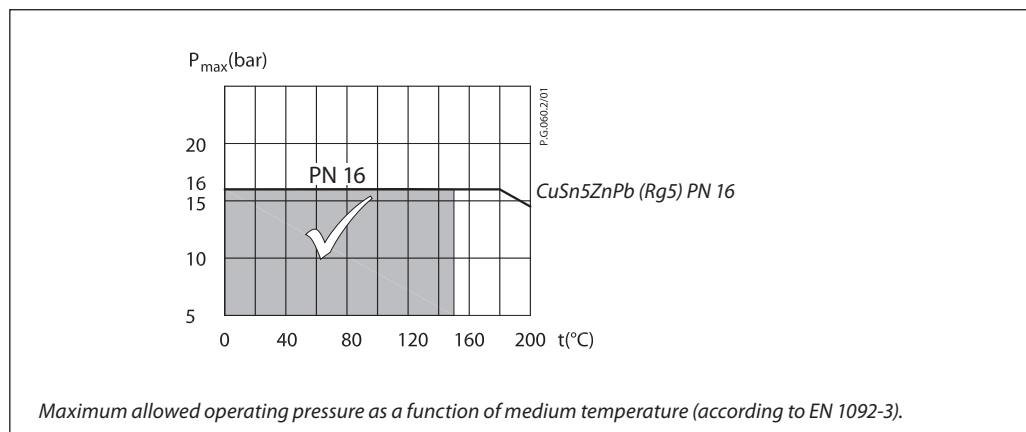

**Design**

- 1. Control valve insert
- 2. Adjustable flow restrictor
- 3. Valve body
- 4. Valve insert
- 5. Pressure relieved valve cone
- 6. Valve stem
- 7. Built-in spring for flow rate control
- 8. Control drain
- 9. Actuator
- 10. Control diaphragm
- 11. Union nut
- 12. Impulse tube
- 13. Compression fitting for impulse tube
- 14. Excess pressure safety valve

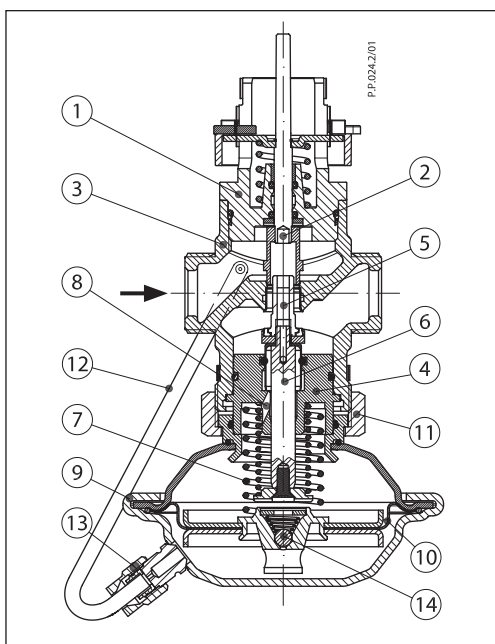

**Function**

Flow volume causes pressure drop across the adjustable flow restrictor. Resulting pressures are being transferred through the impulse tubes and/or control drain in the actuator stem to the actuator chambers and act on control diaphragm for flow control. The flow restrictor diff. pressure is controlled and limited by means of built-in spring for flow control. Control valve closes on rising differential pressure and opens on falling differential pressure to control max flow.

Additionally the electrical actuator will operate from zero to set max. flow according to the load.

Controller is equipped with excess pressure safety valve, which protects control diaphragm for flow control from too high differential pressure.

**Settings**

*Max flow limiting*

Max flow limiting is being done by the adjustment of the flow restrictor position. The adjustment can be performed on the basis of flow adjustment diagram (see relevant instructions) and / or by the means of heat meter.

Dimensions

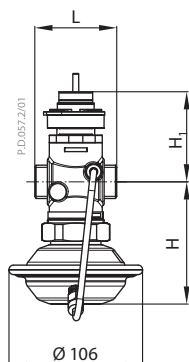

AVQM (DN 15-32)

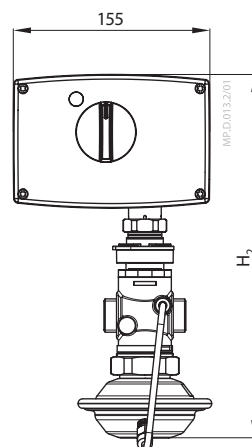

AMV(E) 2./3. + AVQM (DN 15-32)

DN	L	H	H <sub>1</sub>	Weight (kg)
	mm			
15	65	97	72	1.9
20	70	97	72	1.9
25	75	97	75	2.0
32	100	97	76	2.5

DN	H <sub>2</sub>	H <sub>3</sub>	H <sub>4</sub>
	mm		
15	289	276	279
20	289	-	-
25	292	-	-
32	293	-	-

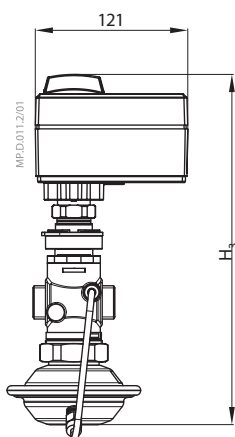

AMV(E) 10 + AVQM (DN 15)

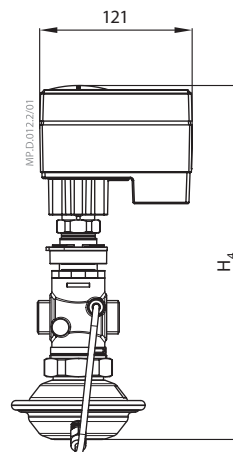

AMV(E) 13 + AVQM (DN 15)

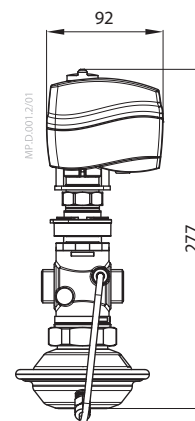

AMV 150 + AVQM (DN 15)

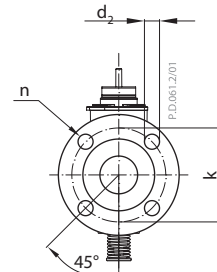
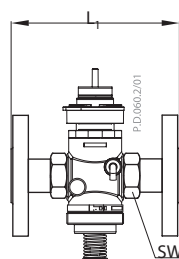
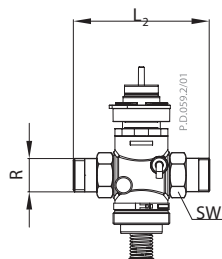
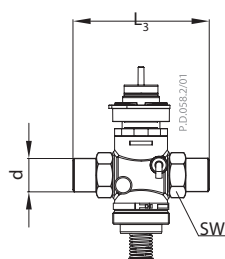

DN	R <sup>1)</sup>	SW	d	L <sub>1</sub> <sup>2)</sup>	L <sub>2</sub>	L <sub>3</sub>	k	d <sub>2</sub>	n
		mm							
15	1/2	32 (G 3/4A)	21	130	120	139	65	14	4
20	3/4	41 (G 1A)	26	150	131	154	75	14	4
25	1	50 (G 1 1/4A)	33	160	145	159	85	14	4
32	1 1/4	63 (G 1 3/4A)	42	-	177	184	100	18	4

<sup>1)</sup> Conical ext. thread acc. to EN 10226-1

<sup>2)</sup> Flanges PN 25, acc. to EN 1092-2



